

# Software Update Procedure

## iLX-W670 & iLX-W670S

7-Inch Mech-Less Receiver with Apple CarPlay and Android Auto with Shallow Chassis

### Introduction

- This installation manual is designed to take you through the step-by-step installation of the firmware version MCU 2.0.68 update for the iLX-W670 and iLX-W670S. Please familiarize yourself with the owners manual (found at [www.alpine-usa.com/support](http://www.alpine-usa.com/support)) and if you still have additional questions please call 1-800-TECH-101.
- This firmware update corrects issues with the following:
  1. Steering Wheel Adapter Mode- Default is set to “On”. When set to on it will require a vehicle specific third party adapter to integrate with the vehicle and the SW1, SW2, and Ground wires from the unit will go to the module. Setting to “Off” allows for manual mapping of buttons.
  2. Demo Mode feature is added. The default setting is off.
  3. The default setting for the key colors is now blue instead of white.
  4. Siri not responding correctly when using CarPlay.

### Caution!

- **Do NOT turn off vehicle's ignition or head unit's power switch while updating.** Some modern vehicles may shut down the ignition (ACC) if the engine is not running for some time. If you are not sure if this applies to your car, leave the engine running while the update is in progress.
- **Do NOT remove the USB flash memory while updating.**
- **Do NOT press any buttons while updating.**
- **Do NOT update while driving.**
- Failing to follow any of these cautions could cause damage to the head unit.

### Step 1: Format The Flash Drive

- 1-1** Only flash drives formatted to FAT32 can be read by the head unit. This means that your flash drive can not be formatted to anything else including NTFS, exFAT, etc.
- 1-2** In Windows the drive can be formatted by right clicking on the drive in file explorer and selecting format as shown in the pictures below.

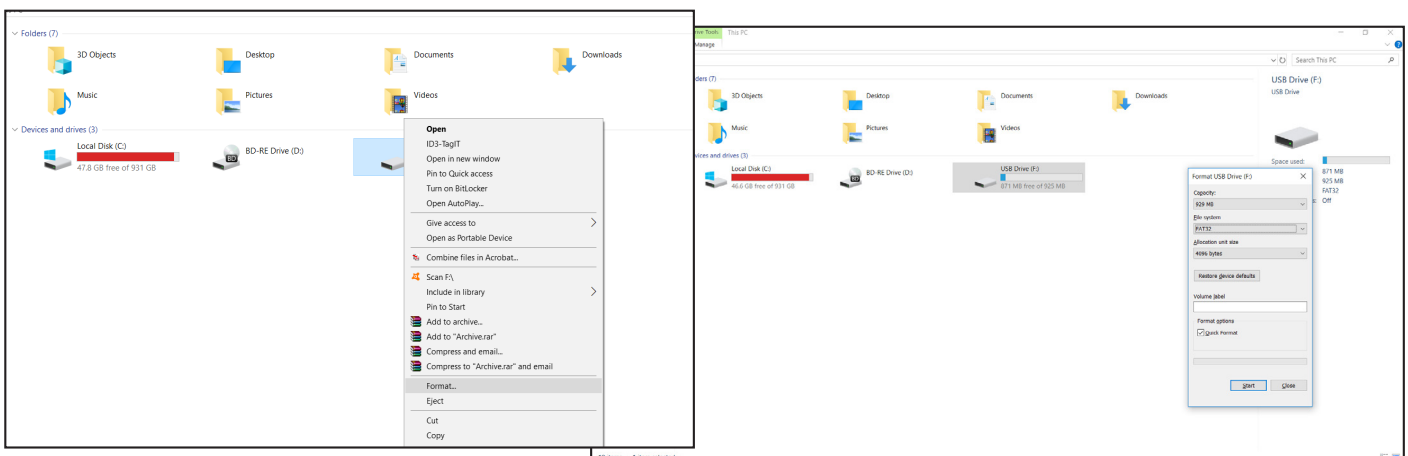

## Step 2: Copy The Update Files To The Flash Drive

**2-1** Extract the downloaded zip file using a program like WinZip to your computer. If you don't have a program that handles zip files on your computer you will need to install one. Current versions of Windows can open .zip files by default.

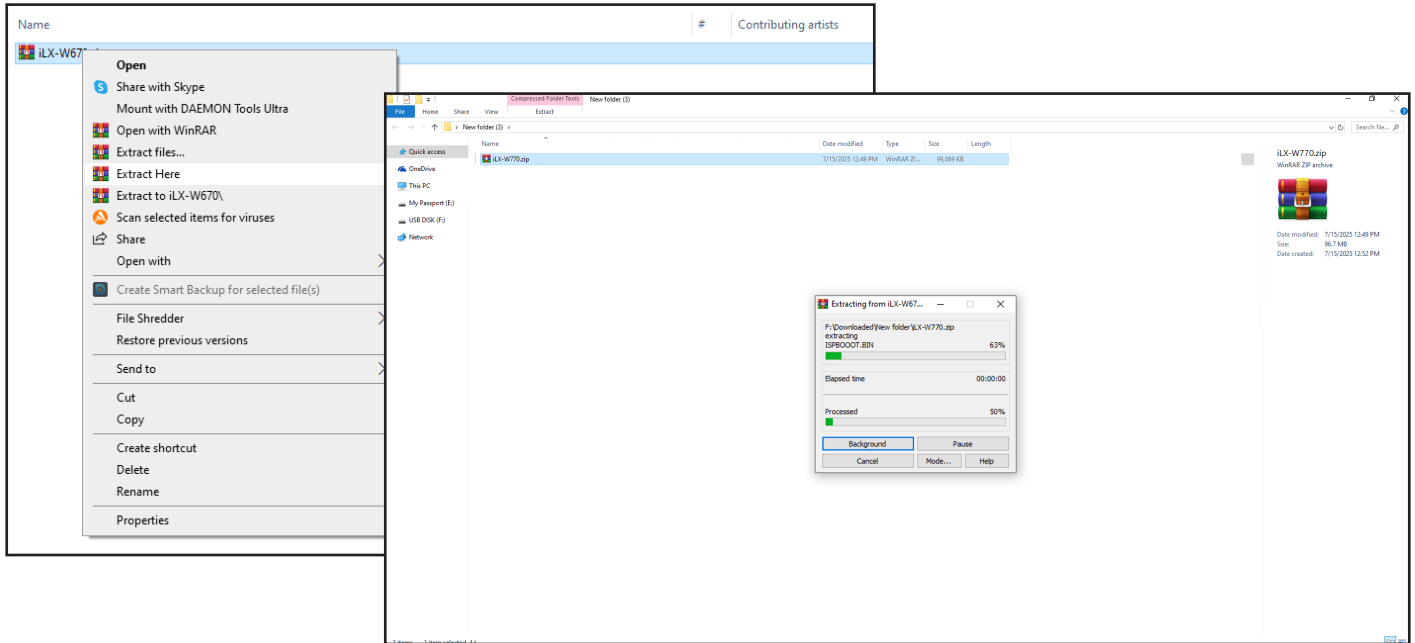

**2-2** Once extracted you will have 3 files named ISPBOOOT.BIN, ISPBOOOT.md5, and mcuupdate.hex. Copy just those files to your flash drive by copy and pasting or dragging and dropping the files. The pictures below show just the root of the thumb drive with only the files in it. Note: You can **NOT** change the file names or folder names. The head unit will not recognize the files if you do. **DO NOT** put the files into another folder and copy that. You must copy only the files.

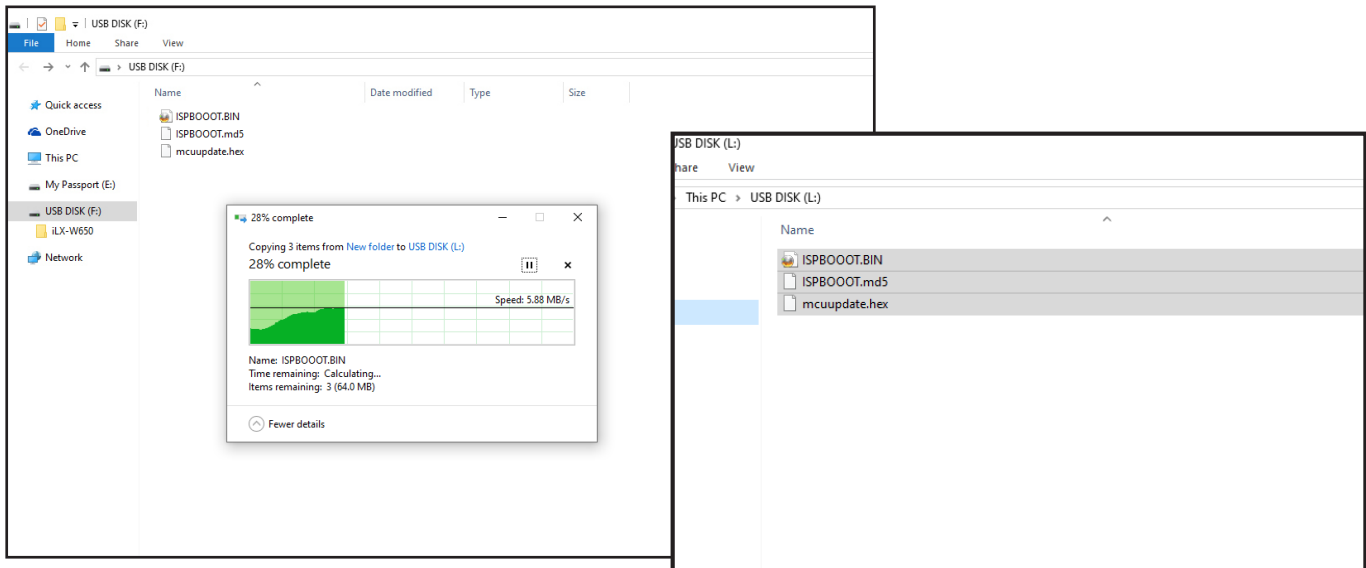

### Notes:

- \*Do **NOT** store any other files on the flash drive. If there is anything on the drive besides the update folder it will not read correctly.
- \*Certain manufacturer's USB memory may not work. If so, try a different manufacturer's USB memory.

## Step 3: Copy The Update Files To The Head Unit

- 3-1** Plug the flash drive into the USB connector of the head unit. The USB extension is typically ran from the back of the head unit to either the glove box or center console areas of the vehicle depending on the original installation.

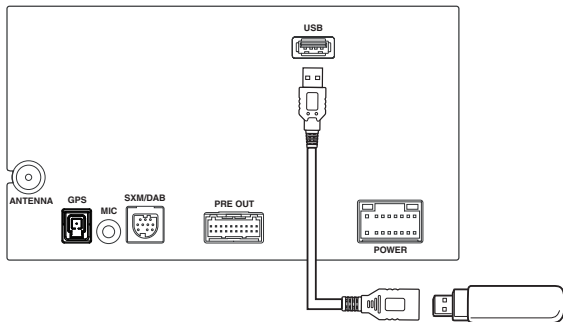

- 3-2** Turn on the vehicle's ignition to power on the head unit. **Do NOT turn off the ignition or the power of the head unit while the system is updating!**

- 3-3** Go to MENU/SETUP/SYSTEM/PRODUCT INFORMATION. Note: As always to get into the settings you will need to do the parking brake sequence. Engage the parking brake, release the parking brake, and engage it a 2nd time.

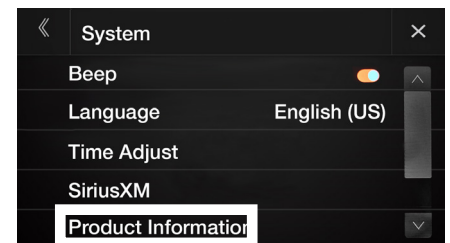
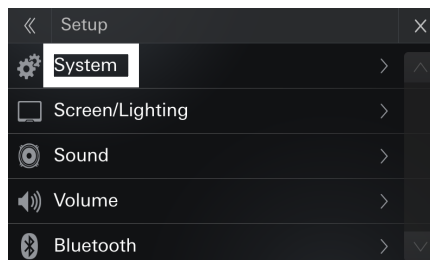

- 3-4** Scroll to the bottom and press Upgrade. A Loading screen will briefly appear, and that will bring up the New Firmware Version screen. Press Update. This process should take about 2 minutes.

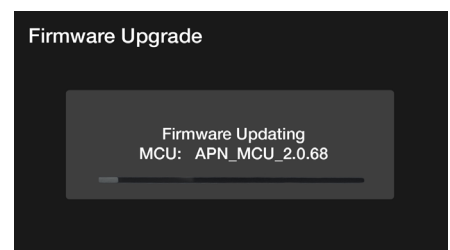
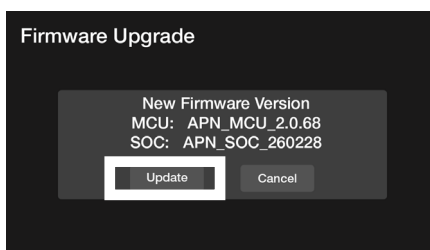
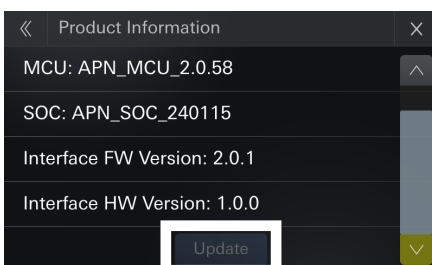

- 3-5** The firmware update screen will automatically change and do the next part of the update. The head unit will reboot when the update has finished. Remove the thumb drive from the USB port. Go back to the SYSTEM menu and press RESET to do a hard reset which will restore everything to the factory default settings. If there's settings that you have changed then please make note of them before doing the reset. Yes, the hard reset is a necessary step.

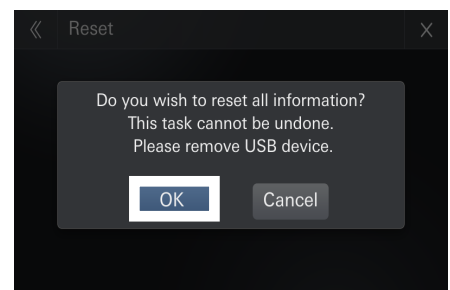
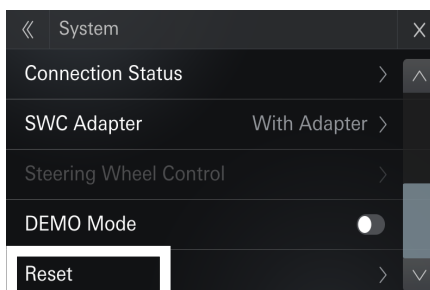
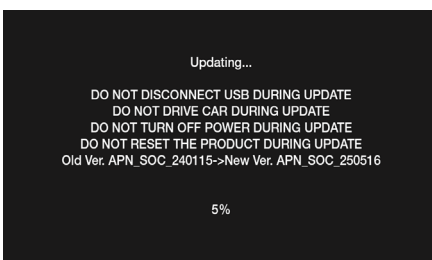

## Troubleshooting Guide

	Symptom	Possible Cause	Remedy
1	Head unit will not read flash memory.	The downloaded software was not unzipped.	Refer to Step 2. The .zip file will need to be unzipped first using your program of choice (for example, WinZip, WinRAR, Izarc, etc).
There are other files on the flash drive.		The flash drive should be freshly formatted (refer to Step 1) and the only files on it should be the downloaded files as shown in Step 2.	
The files were placed in a folder.		Make sure only the three individual files are copied to the thumb drive. They can't be in another folder.	
The USB port was installed incorrectly.		Make sure the port is working correctly by plugging in an iPod or flash memory with a few MP3's on it and seeing if it will play the music. If that's not working then there's no way for the update to work. Try plugging the flash drive directly into the tuner without the extension cable.	
Error Message "The Software Is Not Applicable To This Model"		The wrong firmware was downloaded from the website. Download the firmware for the correct model number head unit.	